

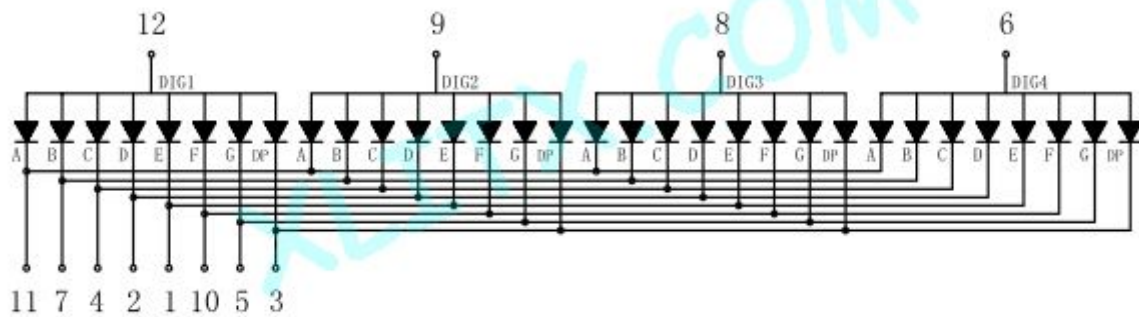

Model :	3461BH
Size :	0.36-inch
Emitting color :	Red (Ultra-Bright)
Mode :	Common-Anode (CA)
Digit :	4-Digit
Category :	LED 7-Segment Display
Maker :	XLITX Technology

Prices : \$0.76 = 100 Pieces \$0.45 = 500 Pieces \$0.40 = 1000 Pieces (Free shipping)

Dimension & Diagram

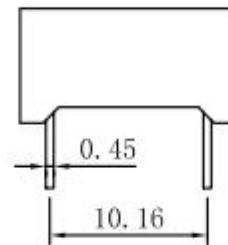
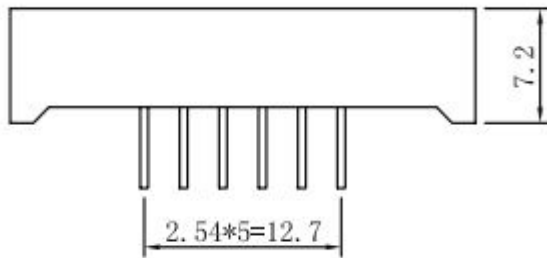
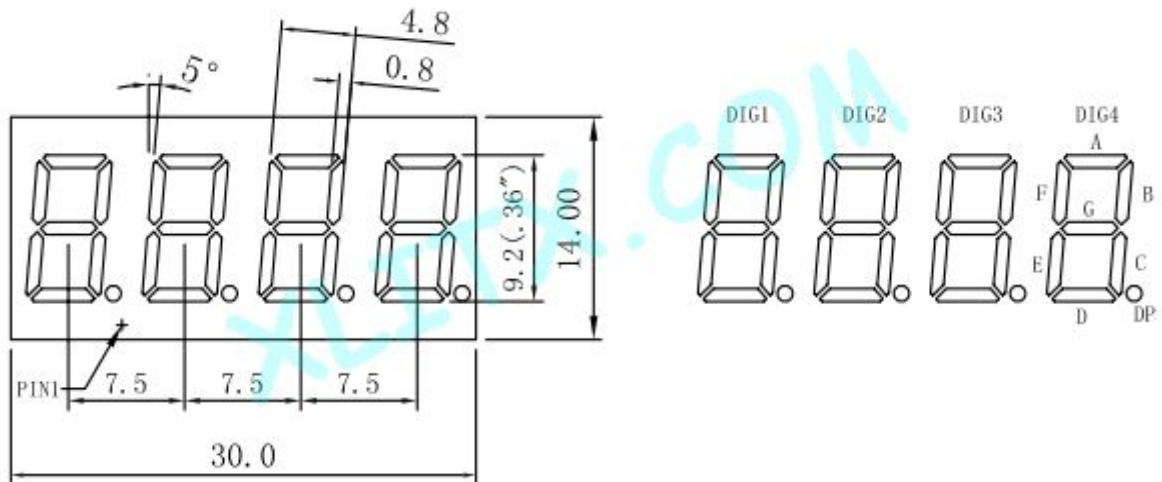

Ultra-Bright Red Electro-Optical Parameter

1. Electro-Optical Characteristics(Ta=25°C)

PARAMETER	SYMBOL	DEVICES (ULTRA-BRIGHT RED)		UNIT	TEST CONDIONS
		TYP	MAX		
Peak Emission Wavelengrth	λ_p	640		nm	IF=10mA
Forward Voltage	VF	1.8		V	IF=10mA
Reverse Current	IR		50	μ A	VR=5V
Segment To Segment (Dot To Dot) Luminonous Intensity Ratio	IV-M	1.5:1			IF=20

2. Absolute Maximun Ratings(Ta=25°C)

PARAMETER	SYMBOL	DEVICES (ULTRA-BRIGHT RED)	UNIT
Power Dissipation Per Dice	pad	100	mw
Derating Linear From 25°C Per Dice		0.5	mA/°C
Continuous Forward Current Per Dice	laf	30	mA
Peak Forward Ourrent Per Dice (Duty Cycle 1/10,10KHz)	lpf	200	mA
Reverse Voltage Per Dice	Vr	5	V
Operating Temperature	Topr	-20°C (to) +75°C	
Storage Temperature	Tstg	-20°C (to) +85°C	
Solder Temperature		1.6 Inch Below Seating Place for 5 seconds at 230°C	

3. Electro-Optical Curve

相对亮度与波长 RELATIVE INTENSITY VS WAVELENGTH



顺电流-顺电压特性
FORWARD CURRENT VS FORWARD VOLTAGE



相对光度-顺电流特性
LUMINOUS INTENSITY VS FORWARD CURRENT



允许顺电流-周围温度特性



相对光度-周围温度特性
LUMINOUS INTENSITY VS AMBIENT TEMPERATURE

